

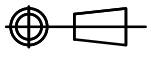



<p><b>SCALE:</b> NTS</p> <p>UNLESS NOTED OTHERWISE</p>	 <p>THIRD ANGLE PROJECTION</p>	<p>© COPYRIGHT LOTUS FOLDING WALLS &amp; DOORS PTY LTD. REPRODUCTION PROHIBITED WITHOUT PERMISSION. CHANGES TO THE DESIGN AND OR DETAILS OF THIS DRAWING MUST NOT BE MADE WITHOUT PERMISSION OF THE R&amp;D DEPARTMENT MANAGER. DO NOT SCALE FROM THIS DRAWING. CHECK ALL DIMENSIONS WITH THE R&amp;D DEPARTMENT MANAGER.</p> <p><a href="http://WWW.LOTUSDOORS.COM.AU">WWW.LOTUSDOORS.COM.AU</a> ABN 61 007 087 523</p>		
<p><b>PRODUCT:</b> 125 SERIES OPERA</p>	<p><b>TITLE:</b> 150 -1 TRACK WITH SWEEP SEALS</p>	<p><b>DRAWING NUMBER:</b> TSD-OP-125-0001</p>	<p><b>LATEST REVISION DATE:</b> 19/11/2019</p>	<p><b>REV</b> 2</p>



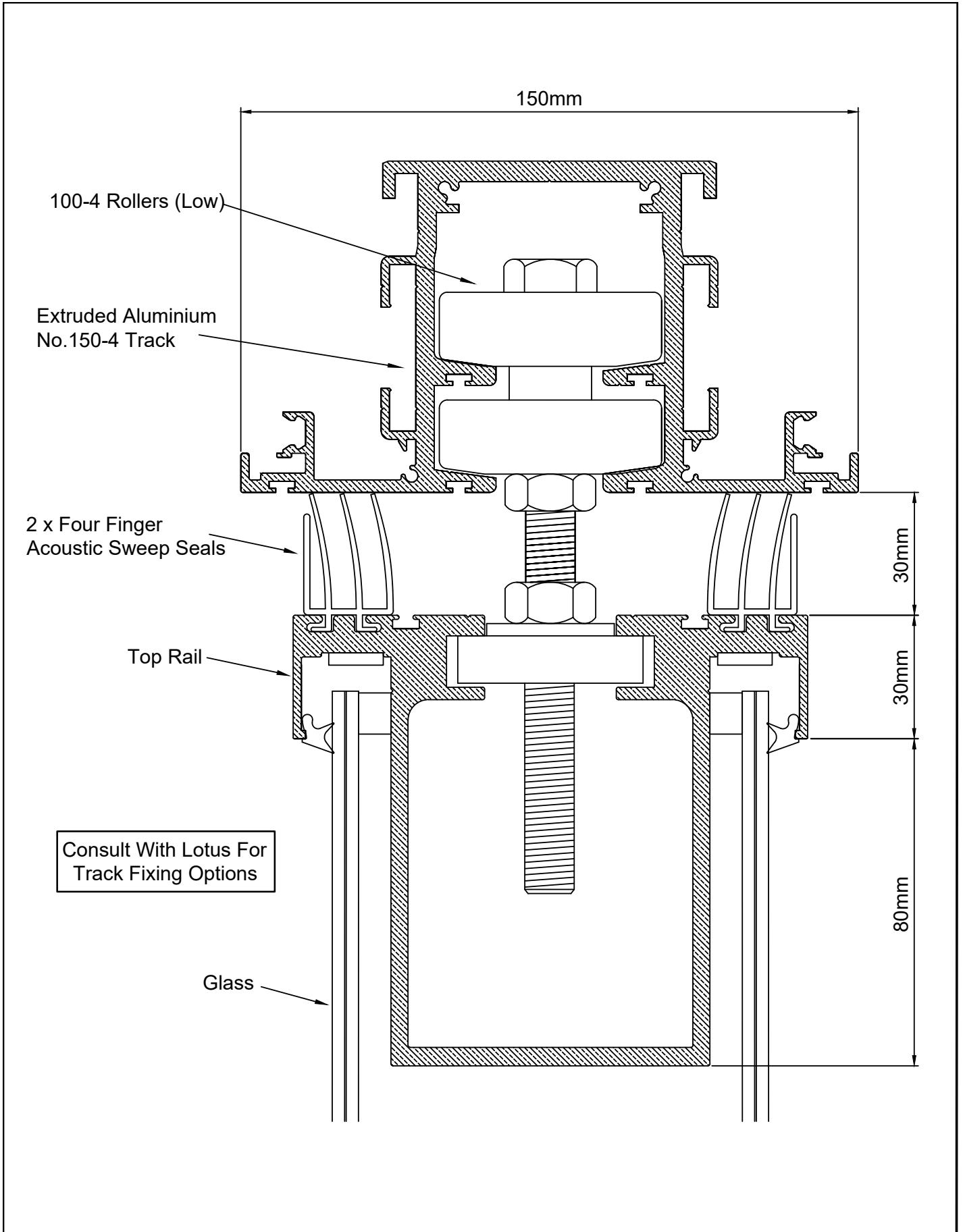
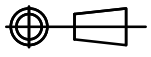

<p><b>SCALE:</b> NTS UNLESS NOTED OTHERWISE</p>	 <p>THIRD ANGLE PROJECTION</p>	<p>© COPYRIGHT LOTUS FOLDING WALLS &amp; DOORS PTY LTD. REPRODUCTION PROHIBITED WITHOUT PERMISSION. CHANGES TO THE DESIGN AND OR DETAILS OF THIS DRAWING MUST NOT BE MADE WITHOUT PERMISSION OF THE R&amp;D DEPARTMENT MANAGER. DO NOT SCALE FROM THIS DRAWING. CHECK ALL DIMENSIONS WITH THE R&amp;D DEPARTMENT MANAGER. <a href="http://WWW.LOTUSDOORS.COM.AU">WWW.LOTUSDOORS.COM.AU</a> ABN 61 007 087 523</p>		
<p><b>PRODUCT:</b> 125 SERIES OPERA</p>	<p><b>TITLE:</b> 150-4 TRACK WITH SWEEP SEALS</p>	<p><b>DRAWING NUMBER:</b> TSD-OP-125-002</p>	<p><b>LATEST REVISION DATE:</b> 19/11/2019</p>	<p><b>REV</b> 2</p>

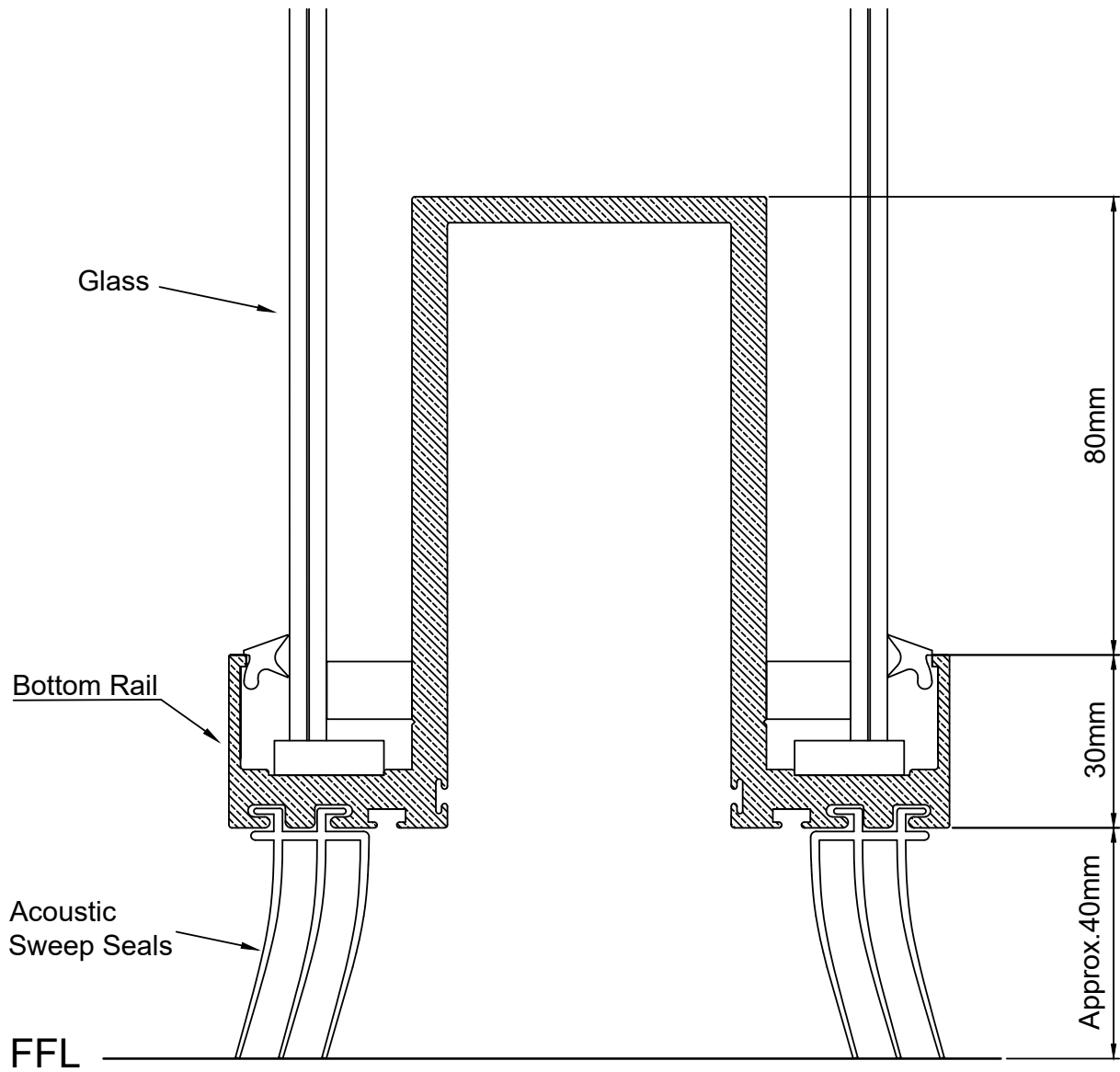
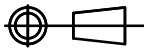

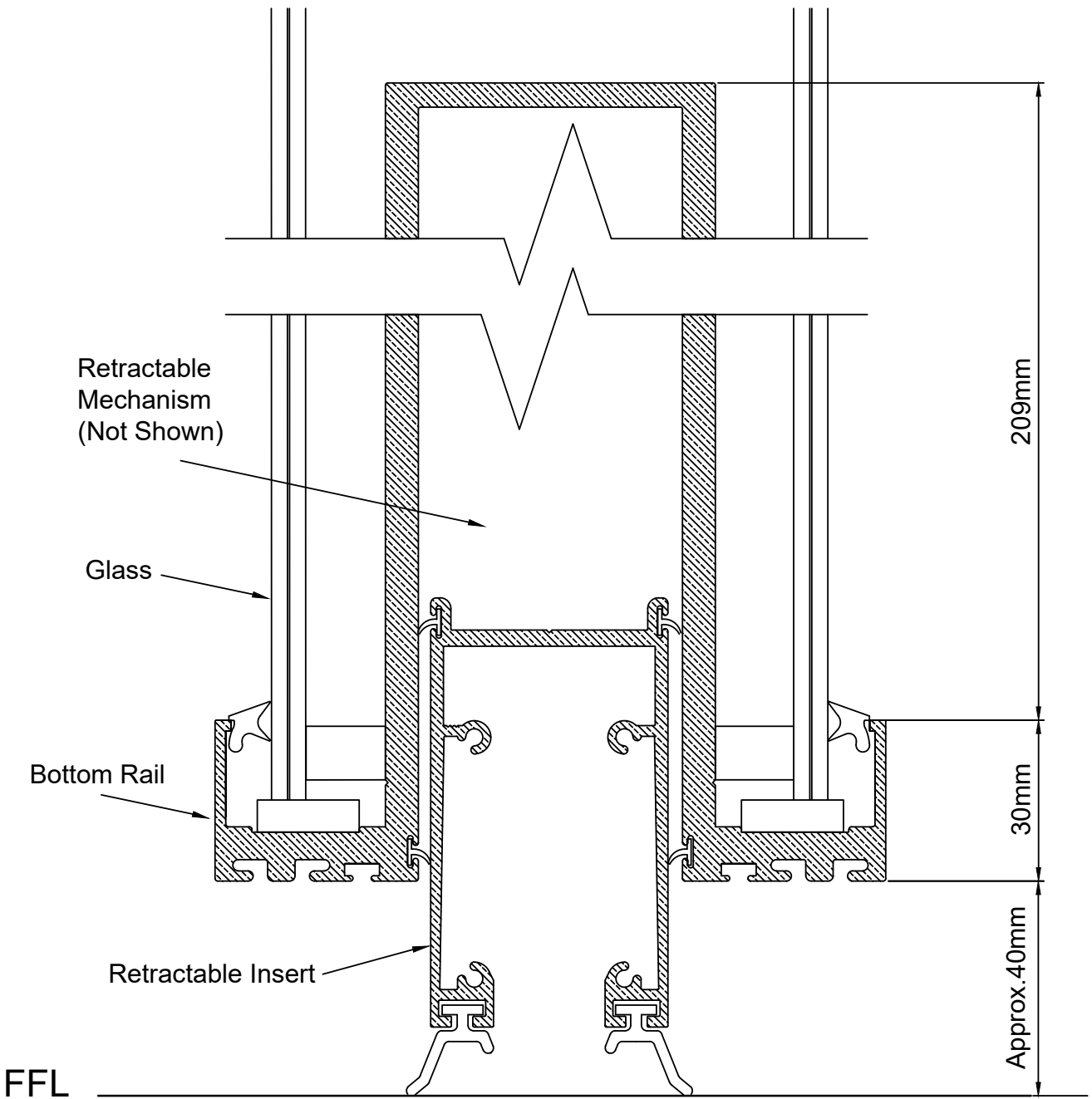

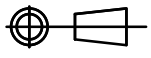
<p><b>SCALE:</b> NTS  UNLESS NOTED OTHERWISE</p>	 <p>THIRD ANGLE PROJECTION</p>	<p>© COPYRIGHT LOTUS FOLDING WALLS &amp; DOORS PTY LTD. REPRODUCTION PROHIBITED WITHOUT PERMISSION. CHANGES TO THE DESIGN AND OR DETAILS OF THIS DRAWING MUST NOT BE MADE WITHOUT PERMISSION OF THE R&amp;D DEPARTMENT MANAGER. DO NOT SCALE FROM THIS DRAWING. CHECK ALL DIMENSIONS WITH THE R&amp;D DEPARTMENT MANAGER.  <a href="http://WWW.LOTUSDOORS.COM.AU">WWW.LOTUSDOORS.COM.AU</a> ABN 61 007 087 523</p>	<h1>LOTUS</h1>	
<p><b>PRODUCT:</b> 125 SERIES OPERA</p>	<p><b>TITLE:</b> BOTTOM RAIL WITH SWEEP SEALS</p>	<p><b>DRAWING NUMBER:</b> TSD-OP-125-0003</p>	<p><b>LATEST REVISION DATE:</b> 19/11/2019</p>	<p><b>REV</b> 2</p>

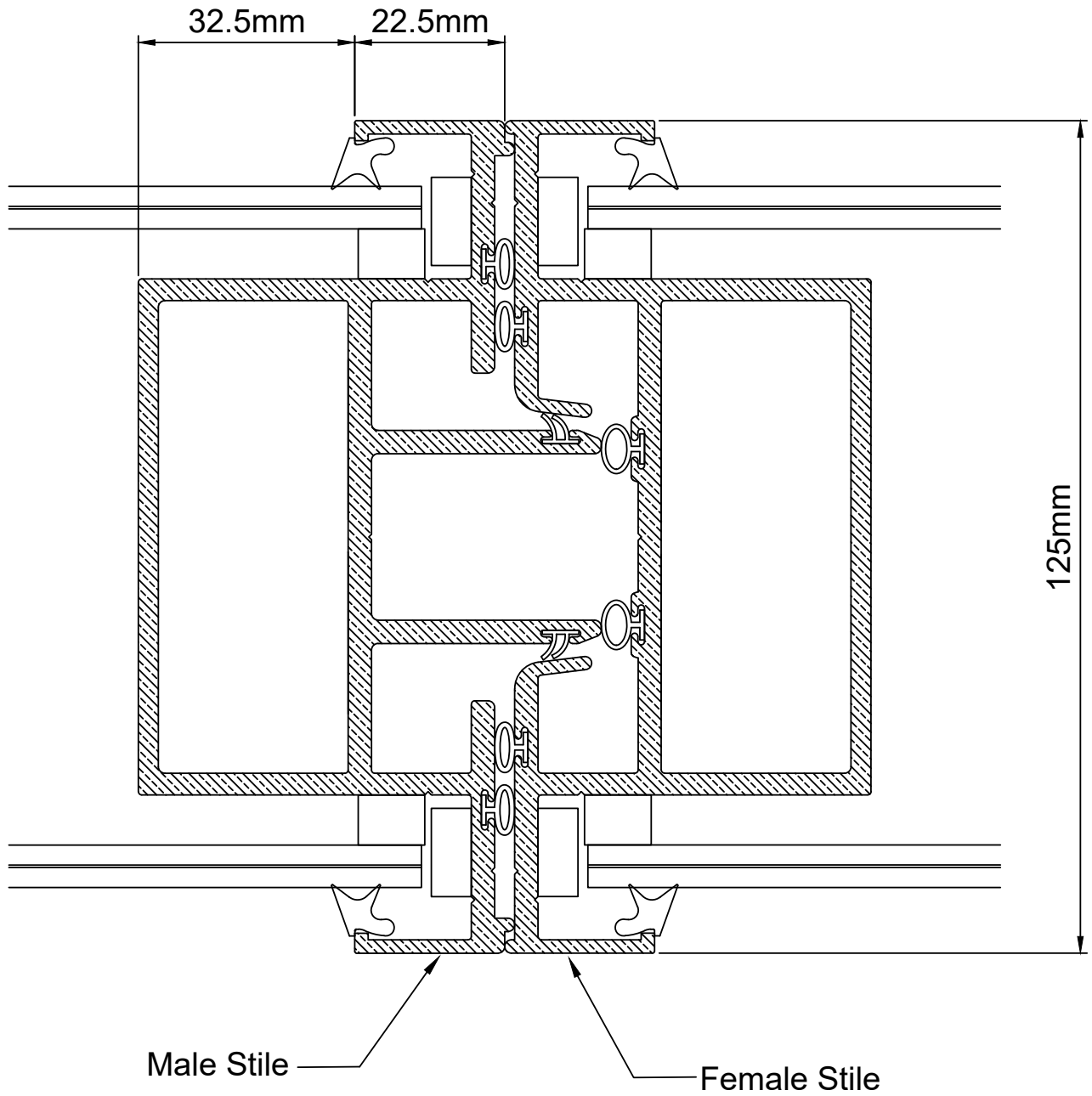

<p><b>SCALE:</b> NTS UNLESS NOTED OTHERWISE</p>	 <p>THIRD ANGLE PROJECTION</p>	<p>© COPYRIGHT LOTUS FOLDING WALLS &amp; DOORS PTY LTD. REPRODUCTION PROHIBITED WITHOUT PERMISSION. CHANGES TO THE DESIGN AND OR DETAILS OF THIS DRAWING MUST NOT BE MADE WITHOUT PERMISSION OF THE R&amp;D DEPARTMENT MANAGER. DO NOT SCALE FROM THIS DRAWING. CHECK ALL DIMENSIONS WITH THE R&amp;D DEPARTMENT MANAGER. <a href="http://WWW.LOTUSDOORS.COM.AU">WWW.LOTUSDOORS.COM.AU</a> ABN 61 007 087 523</p>		
<p><b>PRODUCT:</b> 125 SERIES OPERA</p>	<p><b>TITLE:</b> BOTTOM RETRACTABLE SEALS</p>	<p><b>DRAWING NUMBER:</b> TSD-OP-125-0004</p>	<p><b>LATEST REVISION DATE:</b> 19/11/2019</p>	<p><b>REV</b> 2</p>

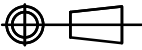

<p><b>SCALE:</b> NTS</p> <p>UNLESS NOTED OTHERWISE</p>	 <p>THIRD ANGLE PROJECTION</p>	<p>© COPYRIGHT LOTUS FOLDING WALLS &amp; DOORS PTY LTD. REPRODUCTION PROHIBITED WITHOUT PERMISSION. CHANGES TO THE DESIGN AND OR DETAILS OF THIS DRAWING MUST NOT BE MADE WITHOUT PERMISSION OF THE R&amp;D DEPARTMENT MANAGER. DO NOT SCALE FROM THIS DRAWING. CHECK ALL DIMENSIONS WITH THE R&amp;D DEPARTMENT MANAGER.</p> <p><a href="http://WWW.LOTUSDOORS.COM.AU">WWW.LOTUSDOORS.COM.AU</a> ABN 61 007 087 523</p>		
<p><b>PRODUCT:</b> 125 SERIES OPERA</p>	<p><b>TITLE:</b> PANEL JUNCTION</p>	<p><b>DRAWING NUMBER:</b> TSD-OP-125-0005</p>	<p><b>LATEST REVISION DATE:</b> 19/11/2019</p>	<p><b>REV</b> 2</p>

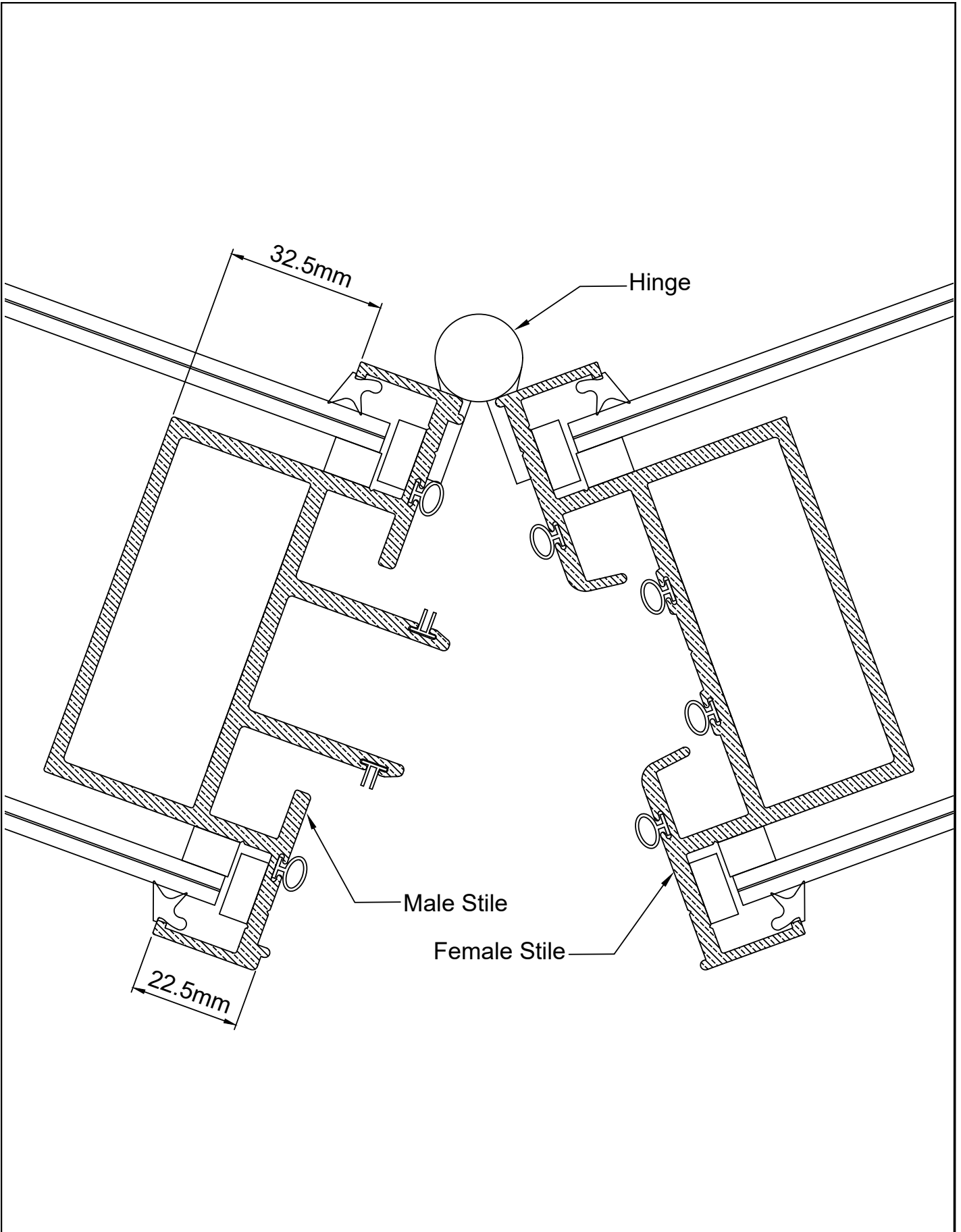

**SCALE:**  
NTS  
UNLESS NOTED OTHERWISE

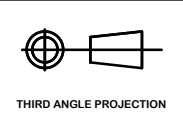

© COPYRIGHT LOTUS FOLDING WALLS & DOORS PTY LTD.  
REPRODUCTION PROHIBITED WITHOUT PERMISSION. CHANGES TO THE DESIGN AND OR DETAILS OF THIS DRAWING MUST NOT BE MADE WITHOUT PERMISSION OF THE R&D DEPARTMENT MANAGER. DO NOT SCALE FROM THIS DRAWING. CHECK ALL DIMENSIONS WITH THE R&D DEPARTMENT MANAGER.  
**WWW.LOTUSDOORS.COM.AU** ABN 61 007 087 523



**PRODUCT:**  
125 SERIES OPERA

**TITLE:**  
PANEL JUNCTION - HINGED PAIR



**DRAWING NUMBER:**  
TSD-OP-125-0006

**LATEST REVISION DATE:**  
19/11/2019

**REV**  
2

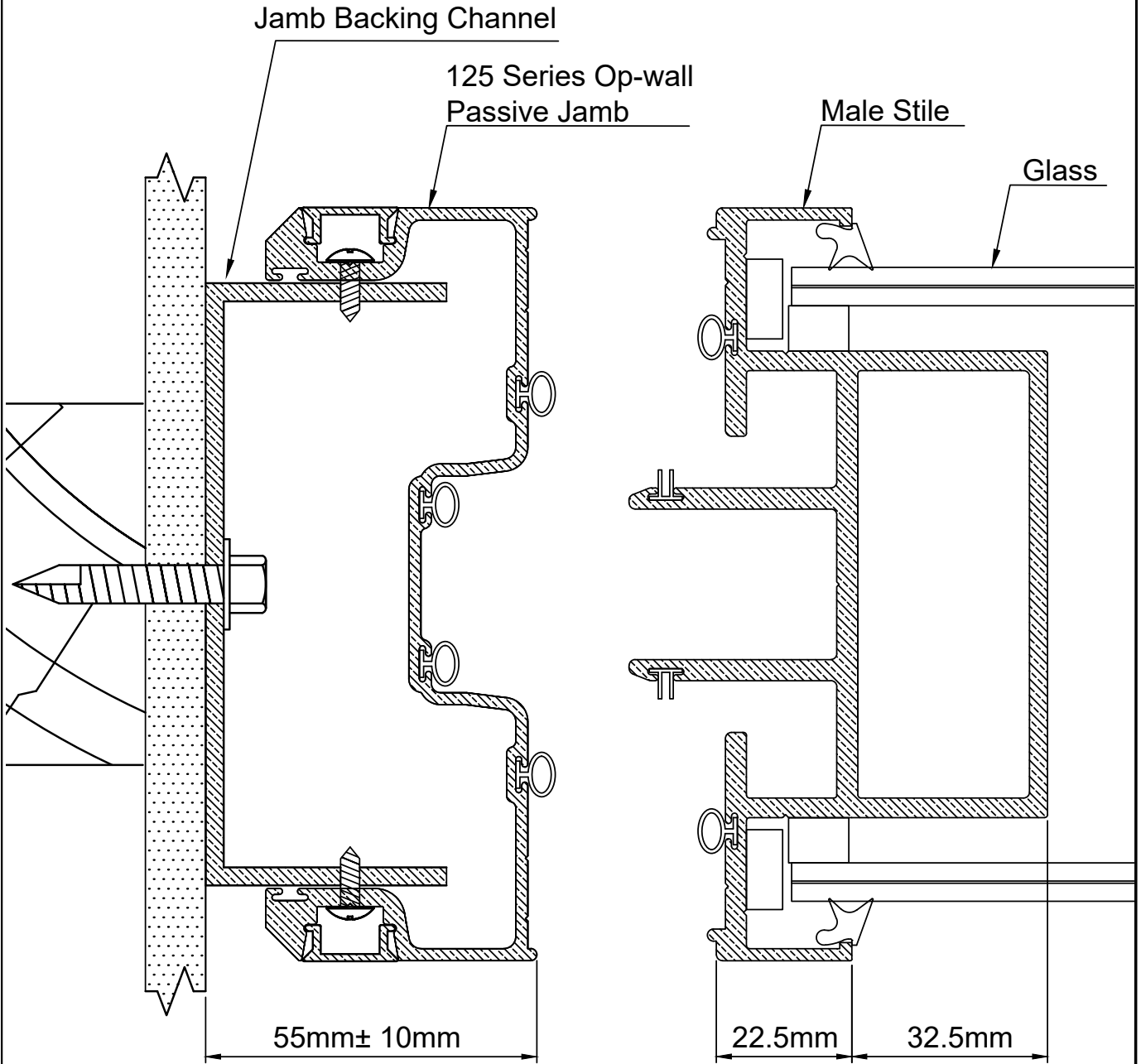
Consult With Lotus For  
Jamb Fixing Options

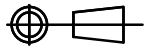

<p>SCALE: NTS</p> <p>UNLESS NOTED OTHERWISE</p>	 <p>THIRD ANGLE PROJECTION</p>	<p>© COPYRIGHT LOTUS FOLDING WALLS &amp; DOORS PTY LTD. REPRODUCTION PROHIBITED WITHOUT PERMISSION. CHANGES TO THE DESIGN AND OR DETAILS OF THIS DRAWING MUST NOT BE MADE WITHOUT PERMISSION OF THE R&amp;D DEPARTMENT MANAGER. DO NOT SCALE FROM THIS DRAWING. CHECK ALL DIMENSIONS WITH THE R&amp;D DEPARTMENT MANAGER.</p> <p>WWW.LOTUSDOORS.COM.AU ABN 61 007 087 523</p>		
<p>PRODUCT: 125 SERIES OPERA</p>	<p>TITLE: PASSIVE JAMB</p>	<p>DRAWING NUMBER: TSD-OP-125-0007</p>	<p>LATEST REVISION DATE: 19/11/2019</p>	<p>REV 2</p>

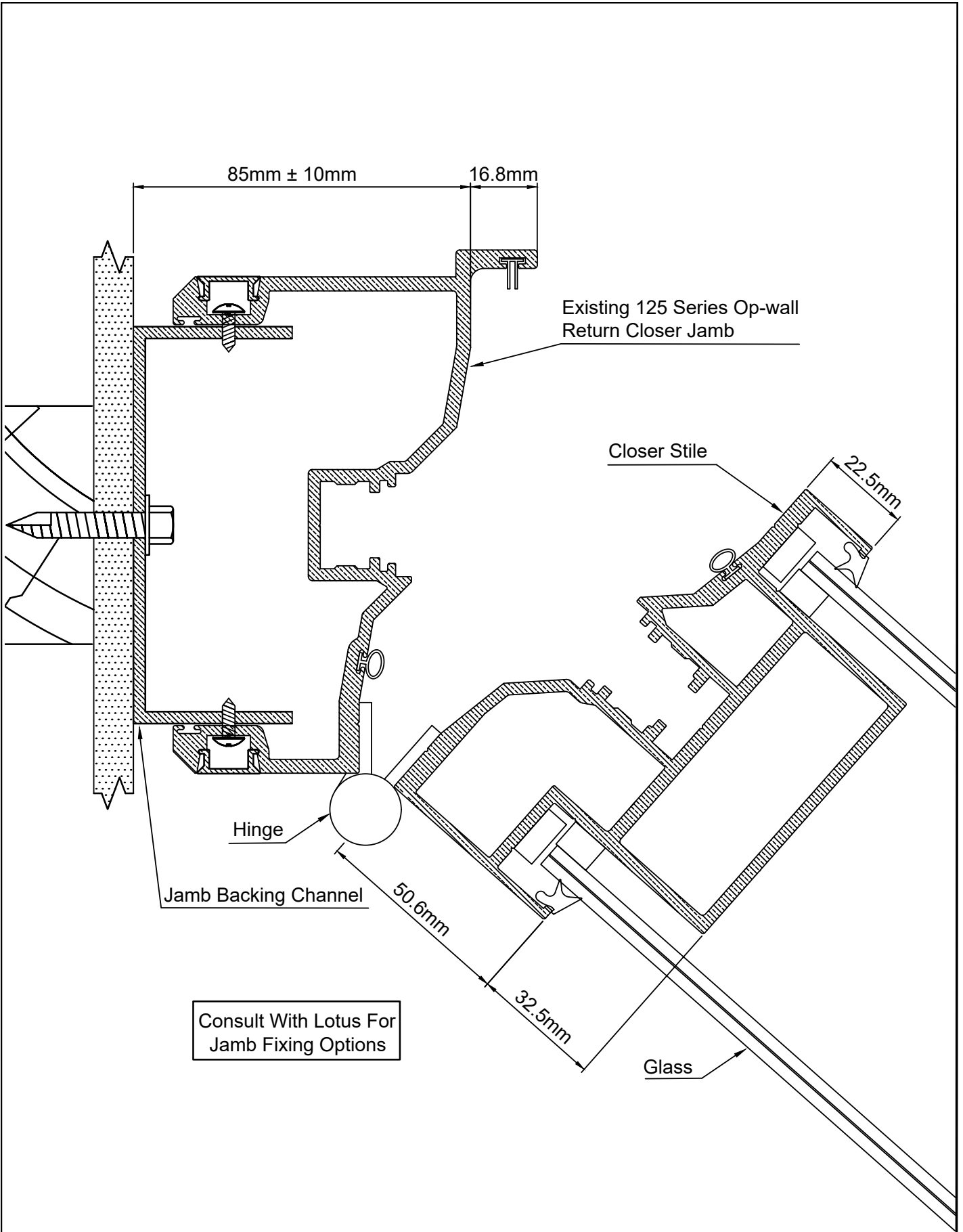

**SCALE:**  
NTS  
UNLESS NOTED OTHERWISE

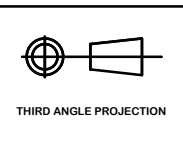

© COPYRIGHT LOTUS FOLDING WALLS & DOORS PTY LTD.  
REPRODUCTION PROHIBITED WITHOUT PERMISSION. CHANGES TO THE DESIGN AND OR DETAILS OF THIS DRAWING MUST NOT BE MADE WITHOUT PERMISSION OF THE R&D DEPARTMENT MANAGER. DO NOT SCALE FROM THIS DRAWING. CHECK ALL DIMENSIONS WITH THE R&D DEPARTMENT MANAGER.  
**WWW.LOTUSDOORS.COM.AU** ABN 61 007 087 523



**PRODUCT:**  
125 SERIES OPERA

**TITLE:**  
RETURN CLOSER JAMB



**DRAWING NUMBER:**  
TSD-OP-125-0008

**LATEST REVISION DATE:**  
19/11/2019

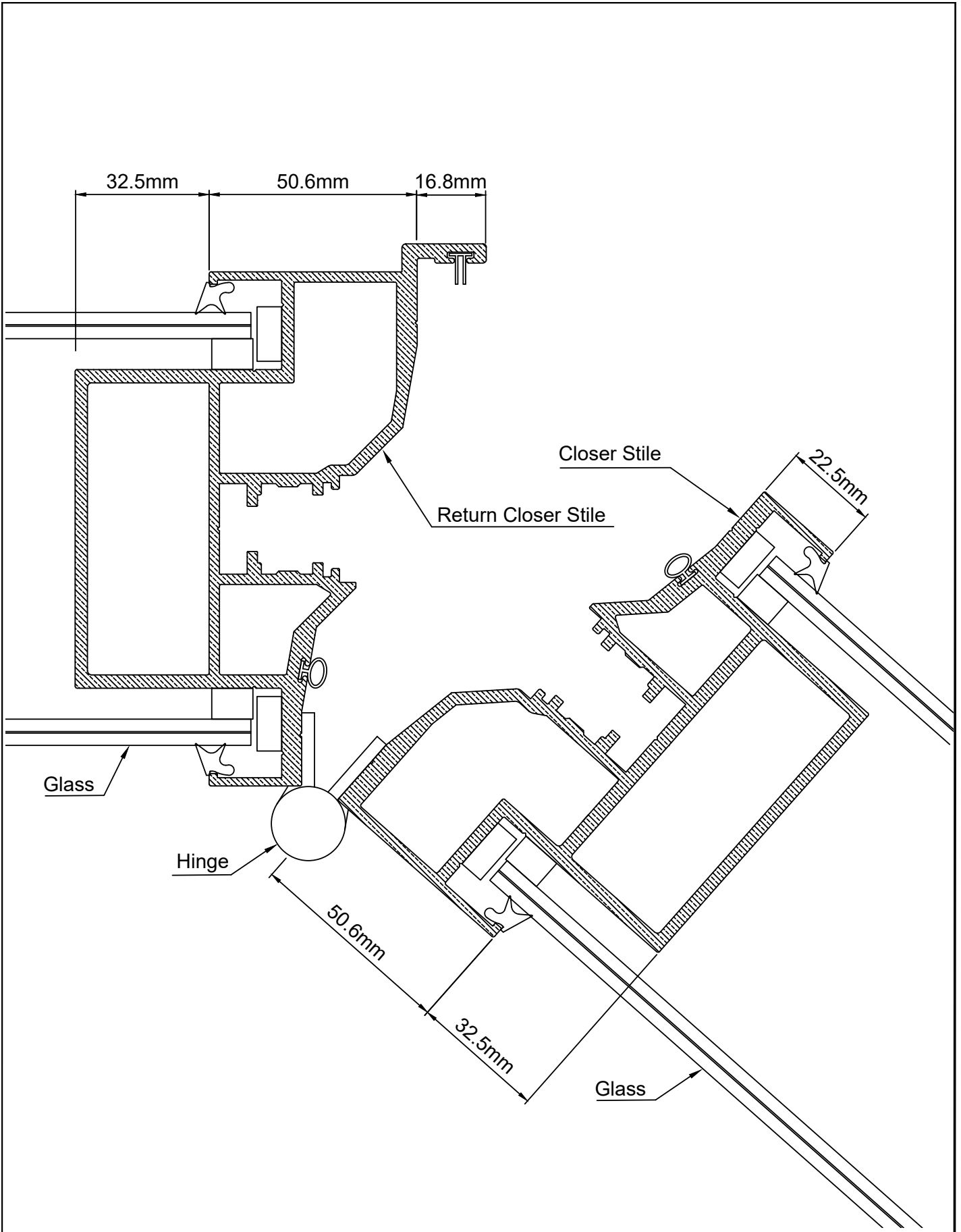

**REV**  
2

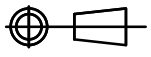



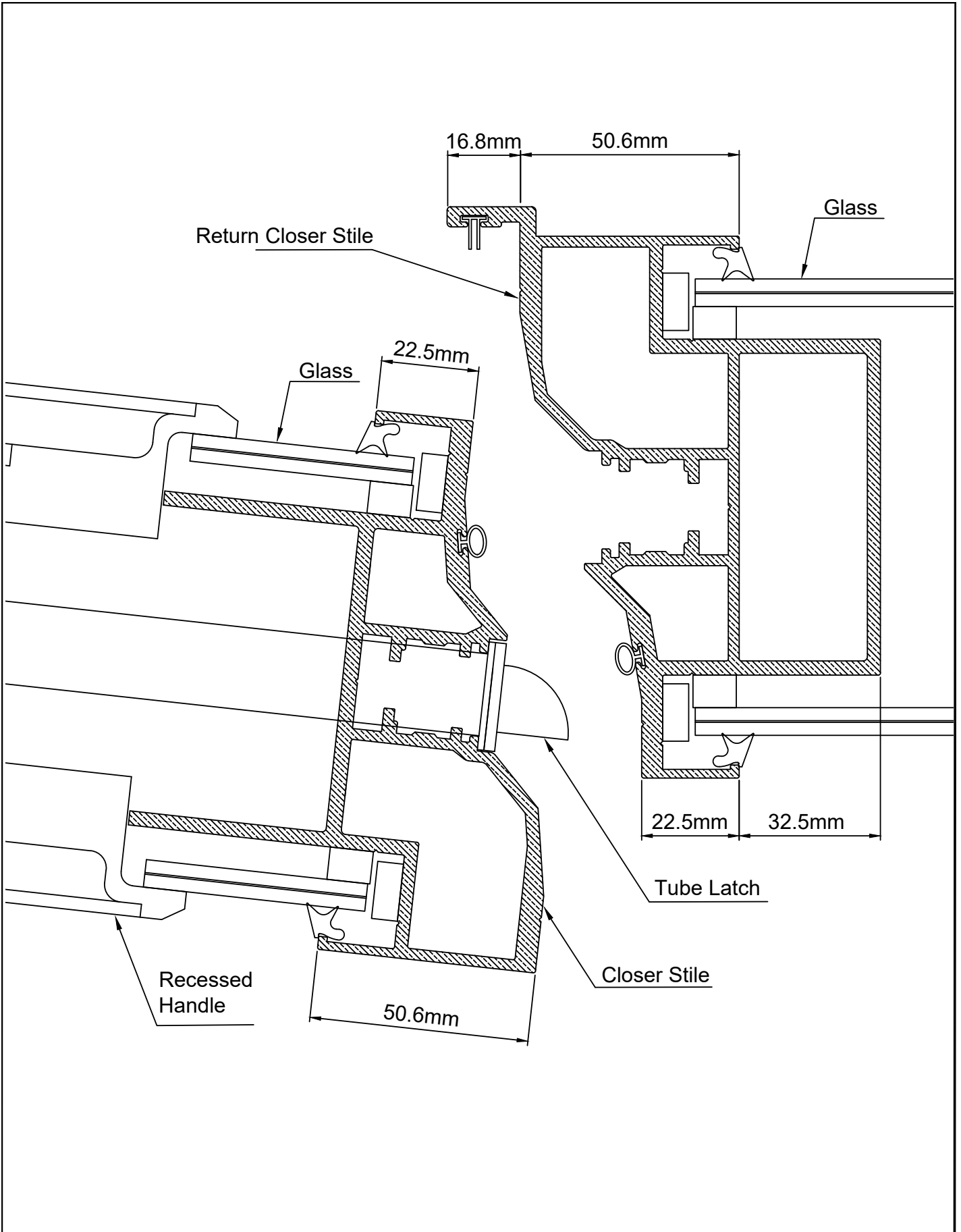

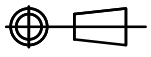
<p>SCALE: NTS</p> <p>UNLESS NOTED OTHERWISE</p>	 <p>THIRD ANGLE PROJECTION</p>	<p>© COPYRIGHT LOTUS FOLDING WALLS &amp; DOORS PTY LTD. REPRODUCTION PROHIBITED WITHOUT PERMISSION. CHANGES TO THE DESIGN AND OR DETAILS OF THIS DRAWING MUST NOT BE MADE WITHOUT PERMISSION OF THE R&amp;D DEPARTMENT MANAGER. DO NOT SCALE FROM THIS DRAWING. CHECK ALL DIMENSIONS WITH THE R&amp;D DEPARTMENT MANAGER.</p> <p>WWW.LOTUSDOORS.COM.AU ABN 61 007 087 523</p>		
<p>PRODUCT: 125 SERIES OPERA</p>	<p>TITLE: PASSDOOR HUNG OF ADJ. PANEL</p>	<p>DRAWING NUMBER: TSD-OP-125-0009</p>	<p>LATEST REVISION DATE: 19/11/2019</p>	<p>REV 2</p>

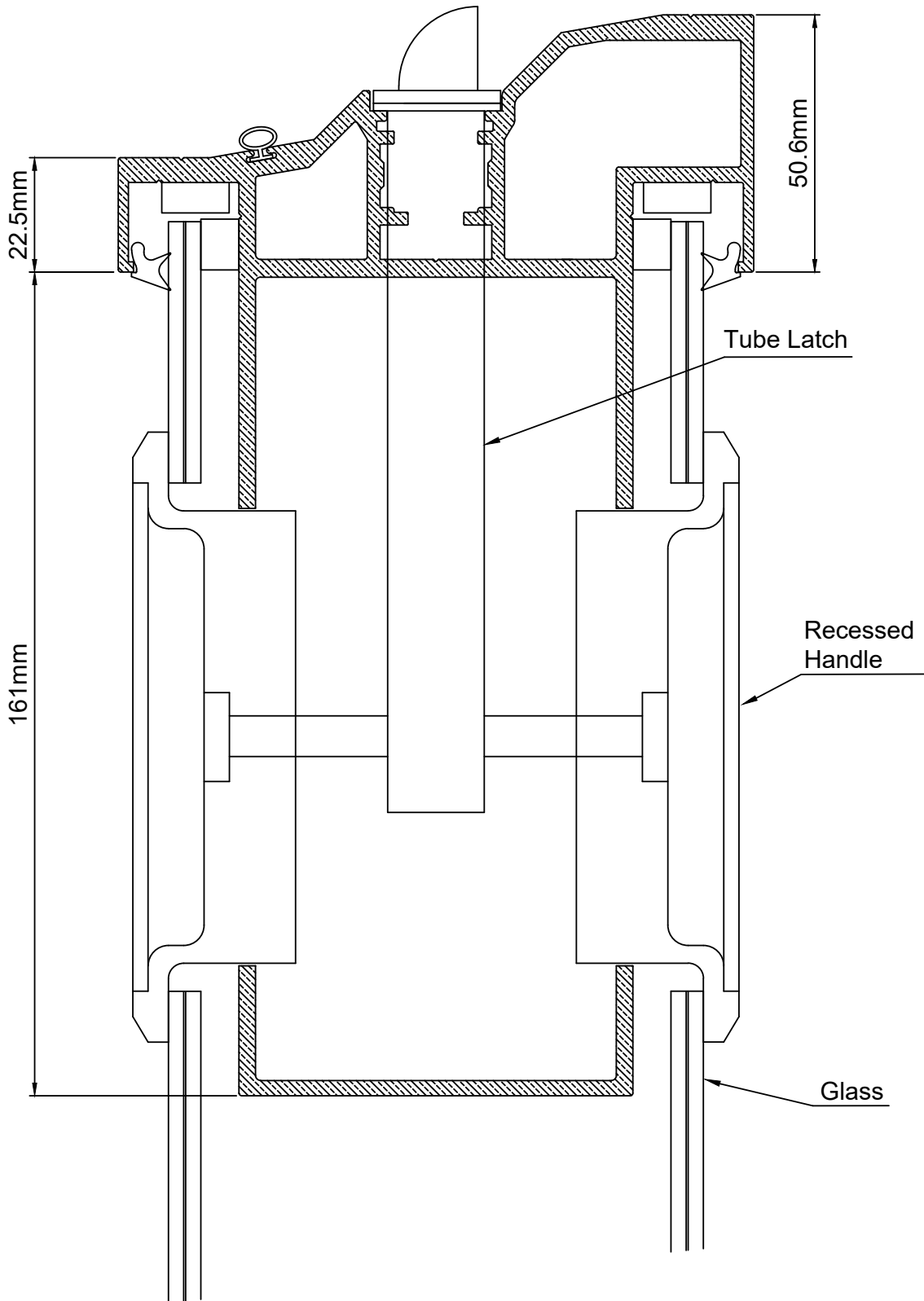

<p><b>SCALE:</b> NTS</p> <p>UNLESS NOTED OTHERWISE</p>	 <p>THIRD ANGLE PROJECTION</p>	<p>© COPYRIGHT LOTUS FOLDING WALLS &amp; DOORS PTY LTD. REPRODUCTION PROHIBITED WITHOUT PERMISSION. CHANGES TO THE DESIGN AND OR DETAILS OF THIS DRAWING MUST NOT BE MADE WITHOUT PERMISSION OF THE R&amp;D DEPARTMENT MANAGER. DO NOT SCALE FROM THIS DRAWING. CHECK ALL DIMENSIONS WITH THE R&amp;D DEPARTMENT MANAGER.</p> <p><a href="http://WWW.LOTUSDOORS.COM.AU">WWW.LOTUSDOORS.COM.AU</a> ABN 61 007 087 523</p>		
<p><b>PRODUCT:</b> 125 SERIES OPERA</p>	<p><b>TITLE:</b> PASSDOOR CLOSING ONTO ADJ. PANEL</p>	<p><b>DRAWING NUMBER:</b> TSD-OP-125-0010</p>	<p><b>LATEST REVISION DATE:</b> 19/11/2019</p>	<p><b>REV</b> 2</p>

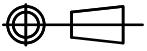

<p><b>SCALE:</b> NTS</p> <p>UNLESS NOTED OTHERWISE</p>	 <p>THIRD ANGLE PROJECTION</p>	<p>© COPYRIGHT LOTUS FOLDING WALLS &amp; DOORS PTY LTD. REPRODUCTION PROHIBITED WITHOUT PERMISSION. CHANGES TO THE DESIGN AND OR DETAILS OF THIS DRAWING MUST NOT BE MADE WITHOUT PERMISSION OF THE R&amp;D DEPARTMENT MANAGER. DO NOT SCALE FROM THIS DRAWING. CHECK ALL DIMENSIONS WITH THE R&amp;D DEPARTMENT MANAGER.</p> <p><a href="http://WWW.LOTUSDOORS.COM.AU">WWW.LOTUSDOORS.COM.AU</a> ABN 61 007 087 523</p>		
<p><b>PRODUCT:</b> 125 SERIES OPERA</p>	<p><b>TITLE:</b> CLOSER STILE - HANDLE</p>	<p><b>DRAWING NUMBER:</b> TSD-OP-125-0011</p>	<p><b>LATEST REVISION DATE:</b> 19/11/2019</p>	<p><b>REV</b> 2</p>